



Update Alert: Firmware updates are posted on the web on a regular basis. We recommend that you check for firmware and/or install guide updates prior to installing this product.

Installation Guide

The CHRYSLER6 firmware for DBALL2 is an all-in-one door lock and override module compatible with specific Dodge/RAM vehicles.

 This module can only be flashed and configured using XpressVIP at www.directechs.com or using the Directechs Mobile application for smartphones. Refer to the Module Programming section on page 7 for more information.



Index

Vehicle Application Guide.....	02
Key2GO & 1KEY.....	03
Installation (Wiring Diagrams & Vehicle Wiring Reference Chart)	
With THCHD3 T-Harness.....	04
Without T-Harness.....	05
Programming	
Module Programming.....	07
Module Reset.....	09
Hard Reset.....	09
Feature & Option List.....	10
Feature Programming.....	11
LED Diagnostics & Troubleshooting.....	12
Limited One-Year Consumer Warranty.....	14
Quick Reference Guide.....	15

Vehicle Application Guide

The table below lists the vehicles and features which are compatible with this product. Refer to the following pages for more information on installation wiring, programming and troubleshooting for these vehicles.

Vehicles						PK-Immobilizer Bypass-Data No Key Req'd	AV-Panic Mode Activation	AV-Parking Lights Control	DL-Arm Factory Security	DL-Disarm Factory Security	DL-Door Lock Control	DL-Door Unlock	DL-Driver Priority Unlock	FOB-Control of aftermarket alarm with OEM remote	Key2GO	RS-RAP Shut Down (Retained ACC Power)	RS-Tach / RPM Output	SS-Entry Monitoring ALL Door Pins	SS-Entry Monitoring Hood Pin	SS-Factory Alarm Trigger Monitoring	ST-Brake Status (foot brake)	ST-Door Locks Status	ST-E-Brake Status	ST-Ignition Status
	2017	2016	2015	2014	2013																			
Dodge/Ram																								
1500	•	•	•	•	•	•	•	•	•	•	•	•	•	D	•	•	•	•	•	D	•	D	•	•
2500	•	•	•	•	•	•	•	•	•	•	•	•	•	D	•	•	•	•	•	D	•	D	•	•
3500	•	•	•	•	•	•	•	•	•	•	•	•	•	D	•	•	•	•	•	D	•	D	•	•

Legend:

- : D2D & Wire-to-Wire (W2W)
- D: Data-to-Data (D2D) only
- W: Wire-to-Wire (W2W)

- PK: Transponder & Immobilizer Override
- AV: Horn & Lights Controls
- DL: OE Door Lock & Alarm Controls
- FOB: Sync CAN Interface w/ FOB Remote
- RS: Remote Start & Engine Controls
- SS: Integrated Security & Monitoring



 This feature is mandatory to control the immobilizer override in this firmware.

Key2GO has been designed and developed to bypass the advanced encryption layers found in modern vehicles. It uses an array of servers to generate a duplicate of the original key, allowing the installation of a remote starter without having to give up a key.

The advantage is that this feature allows you to use one original key and the server to configure the bypass in the vehicle.

All Key2GO-compatible firmware are clearly indicated in the function list of each vehicle search result page and will also appear on the flash page. Any first-time user must re-register to gain access to Key2GO, and some additional information will be required to complete the registration process, such as your Directed account number and store name. Key2GO requires an XKLoader.

Refer to page 8 of this guide for instructions on how to program features using Key2GO.

Wiring Diagram with THCHD3 T-Harness

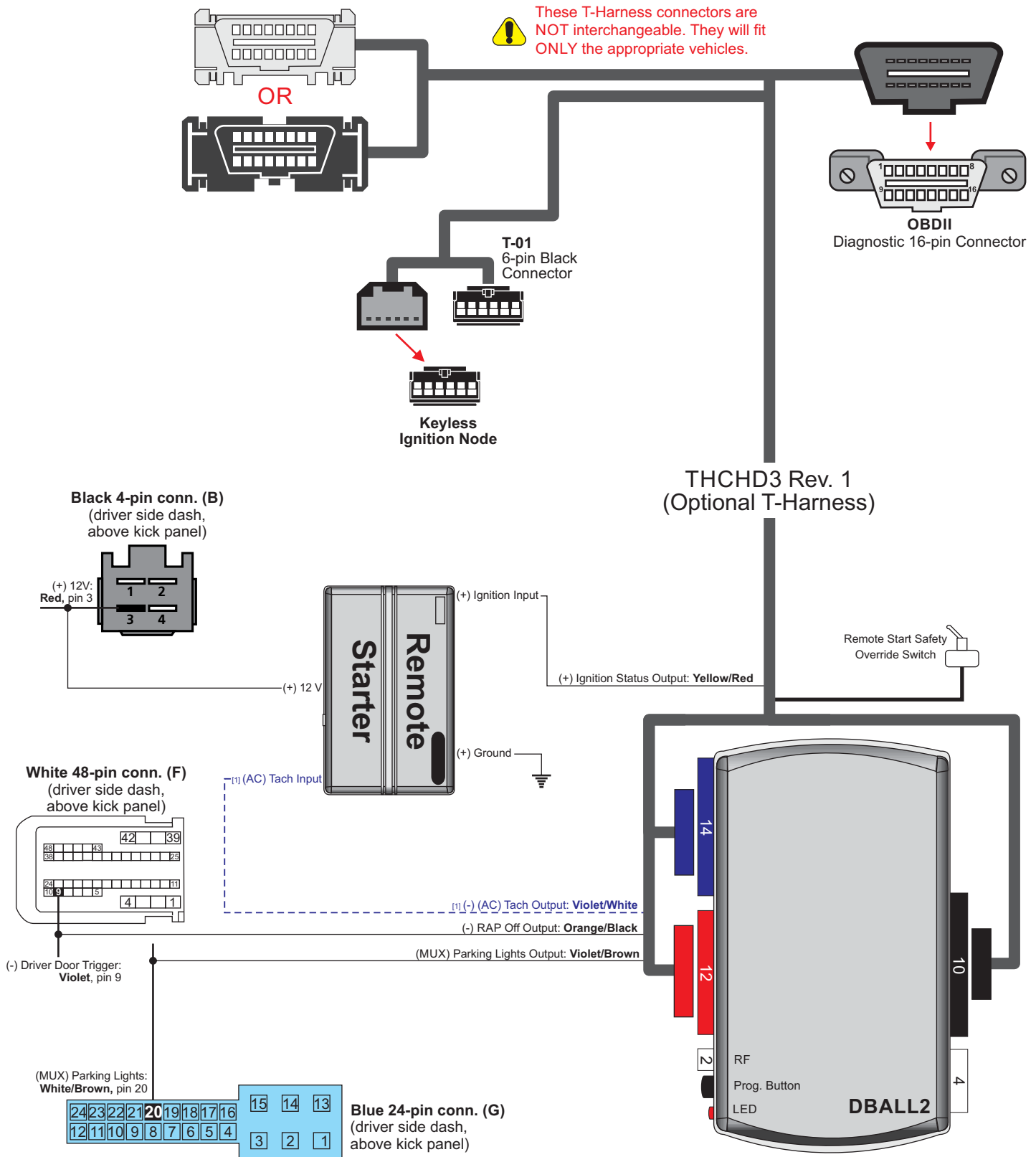

Wiring Diagram without T-Harness

Note: The BCM is located in the driver side dash, above the kick panel.

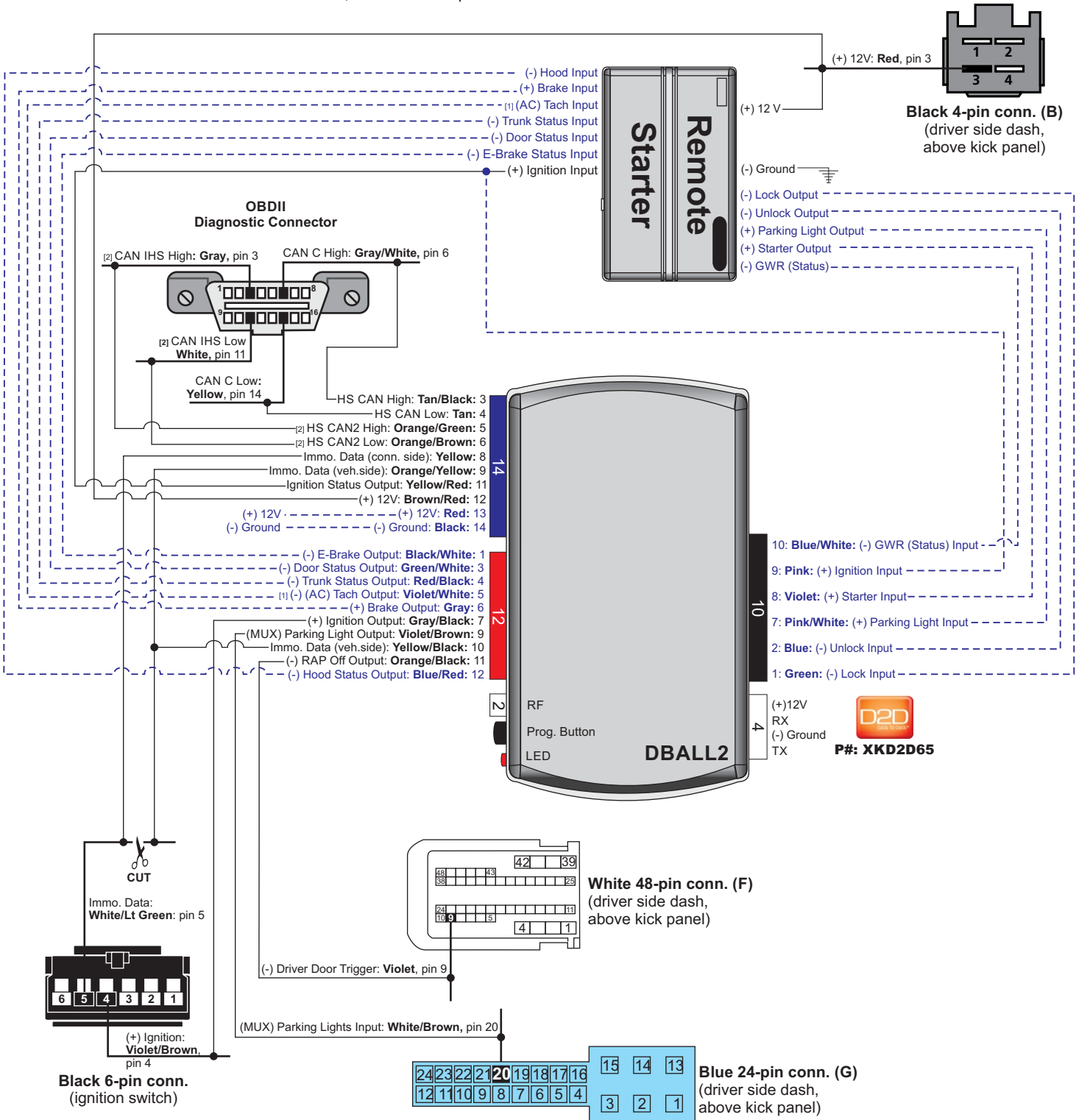

----- Not required in D2D mode.

Vehicle Wiring Reference Chart

Wire Information				Connector Information		
Function	Color	Pin	Polarity	Location	Color	Pins
Dodge RAM 1500/2500/3500 2013-2017						
HS CAN1 High	Gray/White	6	Data	OBDII diagnostic connector.	Black	16
HS CAN1 Low	Yellow	14	Data	OBDII diagnostic connector.	Black	16
HS CAN2 High	Gray	3	Data	OBDII diagnostic connector.	Black	16
HS CAN2 Low	White	11	Data	OBDII diagnostic connector.	Black	16
12V	Red	3	(+)	BCM under driver dash at connector B.	Black	4
Parking Lights	White/Brown	20	MUX	BCM under drivers dash at connector G.	Blue	24
Driver Door Trigger	Violet	9	(-)	BCM under drivers dash at connector F.	White	48
Immobilizer Data	White/Lt.Green	5	Cut	Ignition switch	Black	6
Ignition	Violet/Brown	4	(+)	Ignition switch	Black	6

Module Programming

 Refer to the LED Diagnostics section on pages 12-13 for more information and for troubleshooting purposes.

Important

Make all the required connections to the vehicle, as described in the wiring diagram(s) found in this guide, and double check to ensure everything is correct prior to moving onto the next step.

 **Warning!** To take advantage of advanced features, you must use XpressVIP 4.5 (and higher) or the Directechs Mobile app.

Flashing a module using your computer:

1. Connect the interface module to your computer using the XKLoader2.
2. Go to www.directechs.com using Internet Explorer, and select the **Flash Module** button.
3. Follow the instructions to select your vehicle, installation type, and configure your options.
4. Once you have configured the firmware options, click on the **FLASH** button.

Flashing a module using your smartphone or tablet

1. Connect the interface module to your XKLoader3.
2. Launch the Directechs Mobile app on your smartphone or tablet.
3. Select **FLASH YOUR MODULE** and follow the on screen instructions.

When the flashing operation is successful, you can proceed with the programming instructions below.

D2D Installation

If required for your installation, connect the 10-pin, 12-pin and 14-pin harnesses to the module, then connect the 4-pin D2D harness.

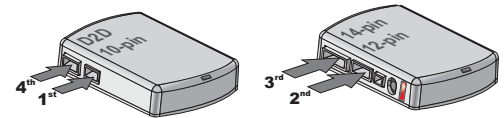

OR

W2W Installation

If required for your installation, connect the 10-pin and 12-pin harnesses to the module, then connect the 14-pin harness to the module.

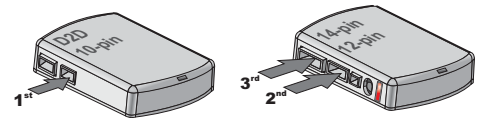

Wait until the LED turns ON solid red.

1

Note: To skip the transponder programming and use convenience features only, press the programming button 5 times. The LED will turn orange then proceed to step 2.



Solid

Insert the key, turn key ON then OFF, remove the key.

2

Insert the key and turn the key ON again. The LED flashes orange slowly. Remove the key.

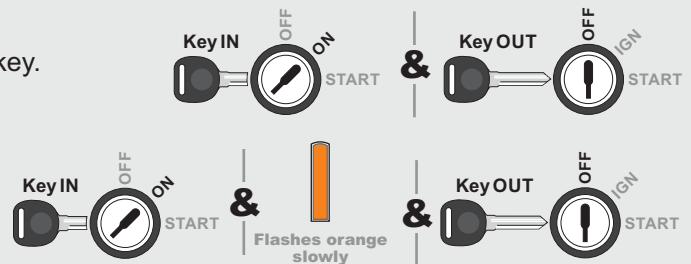

3

Disconnect the module and complete the **Key2GO** programming.

Go to the next page to complete the module programming. 

Web Programming (for Key2GO)

 Refer to the LED Diagnostics section on pages 12-13 for more information and for troubleshooting purposes. Version 4.5 or higher of XpressVIP must be installed on your computer to complete this programming sequence.

1 Remove the module from the vehicle and reconnect it to your computer. The web site will automatically recognize that you are moving onto the second phase of the programming sequence.

2 Click on **Submit Key2GO Request**.

3 Once the configuration is completed, reconnect the module. The LED turns ON solid green for 3 seconds, then turns off.

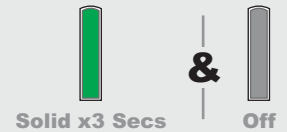

You have successfully completed the module programming sequence.

Module Reset

A module reset will only erase programming performed in the previous steps. All settings (firmware) and settings flashed to the module using the web config tool will not be affected.

D2D Installation

If required for your installation, connect the 10-pin, 12-pin & 14-pin harnesses to the module. Press and hold the programming button, then connect the 4-pin D2D harness.

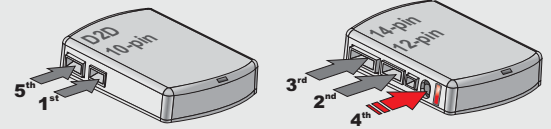

1 **OR**

W2W Installation

If required for your installation, connect the 10-pin & 12-pin harnesses to the module. Press and hold the programming button, then connect the 14-pin harness to the module.

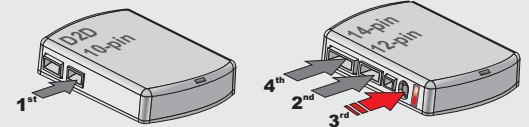

2 Wait 3 seconds until the LED turns ON solid orange then release the programming button. The LED then turns ON solid red.



Hard Reset

Warning Against Executing a Hard Reset!

A hard reset will revert the flashed firmware back to its default settings. Depending on the installation, some settings (such as RFTD and D2D options) may have to be reconfigured. See the **Feature & Option List** section of this guide.

D2D Installation

If required for your installation, connect the 10-pin, 12-pin & 14-pin harnesses to the module. Press and hold the programming button, then connect the 4-pin D2D harness.

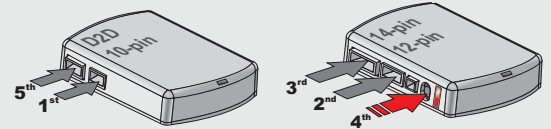

1 **OR**

W2W Installation

If required for your installation, connect the 10-pin & 12-pin harnesses to the module. Press and hold the programming button, then connect the 14-pin harness to the module.

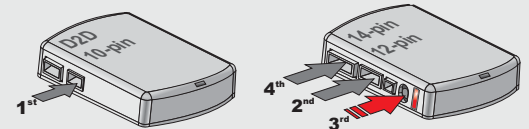

2 Wait 3 seconds until the LED turns ON solid orange, and wait 10 more seconds until the LED starts to flash orange and red.



3 Release the programming button. The LED turns ON solid red.



Feature & Option List

It is recommended to configure all the features and options listed below using the configuration tool found on the module flashing page on www.directechs.com. The web offers more options; however, manual configuration of the features is possible using the information on this page.

* Default option

Feat.	Operation	Flashes / Option	Description
1	RF Output Type	1. Disabled*	Module is connected to a remote starter using a standard installation.
		2. RFTD Output	Module is connected to an XL202 using an RSR or RXT installation (when available).
		3. SmartStart	Module is connected to SmartStart using an RSR or RXT installation (when available).
2	Unlock Driver Priority	1. Driver Priority*	Unlocks only the driver door on first press and unlocks all doors on a second press within 5 seconds.
		2. All	Unlocks all doors on first press.
3	Heated Seats	1. Disabled*	No operation.
		2. Enabled	When the feature is enabled, it will activate the heated seats and heated steering wheel.
4	Defroster	1. Disabled*	No operation.
		2. Enabled	When the feature is enabled, it will activated the rear defrosrter and heated mirrors.
5	Heated Seats/Defroster Temperature Control	1. 32° Farenheit (0°Celsius)*	When Heated Seats or Defroster feature is enabled, it will activate the feature upon remote start when temperature is below 32 °F (0 °C)
		2. 23° Farenheit (-5°Celsius)	When Heated Seats or Defroster feature is enabled, it will activate the feature upon remote start when temperature is below 23 °F (-5 °C)
		3. 41° Farenheit (5°Celsius)	When Heated Seats or Defroster feature is enabled, it will activate the feature upon remote start when temperature is below 41 °F (5 °C).
		4. Always ON	When Heated Seats or Defroster feature is enabled, it will activate the feature at any temperature.
6	Heated Seats Temperature Level	1. High*	When Heated Seats are activated, they will be set to HIGH.
		2. Low	When Heated Seats are activated, they will be set to LOW.
7	Smart OEM Alarm Control	1. Disabled	The OEM alarm will not be controlled by DBALL upon remote start. No disarm or arm command will be executed at the beginning or end of the sequence; it must be controlled by the Remote Starter.
		2. Normal / Safelock	Smart OEM Alarm Control will behave like a standard Safelock feature on a remote starter. It will unlock at the beginning of the sequence, and relock after start and shutdown.
		3. Enabled*	Smart OEM Alarm Control will synchronize with the OEM alarm so that it will disarm and rearm the vehicle in the remote start sequence, only when required. The reason for this is, factory alarm control must often be done by lock or unlock operation. This could create unnecessary actions on door lock modules, such as the horn to honk. When possible, Smart OEM Alarm Control will monitor the alarm and door lock status to detect if the disarm or rearm is required. If the vehicle is unlocked or is not equipped with factory alarm, the disarm/rearm will not be executed. Smart OEM Alarm Control will also monitor the remote starter actions so that the factory alarm control is not done twice. A remote starter, for which the Safelock feature is active, will work perfectly with this option and will make it invisible to the user.

Feature Programming

Programming
Button

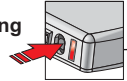

To enter feature programming routine

- Turn the ignition ON, then OFF.
- **Within 5 seconds**, press and HOLD the programming button until the LED turns ON orange (after 3 seconds). Release the Programming button.
- The LED will flash green once slowly to indicate the feature number is 1. After a short delay, the LED flashes red rapidly to indicate the current option of feature 1 (i.e. 1x green followed by 1x red indicates feature 1 is set to option 1). The flashing sequence will repeat until a new command is entered.

Changing feature options

- Press the lock/arm or unlock/disarm button on aftermarket transmitter to change the option of the selected feature.
- The LED flashes red rapidly the number of times equal to the current option number. After a short delay, the LED flashes green slowly the number of times to indicate the current feature. The flashing sequence will repeat until a new command is entered.

Accessing another feature

- Press and release the programming button a number of times to advance from the current feature to the next desired feature.
- The LED flashes green slowly the number of times equal to the feature number. After a short delay, the LED flashes red rapidly to indicate the current option of the current feature. The flashing sequence will repeat until a new command is entered.

When the maximum number of features or options is reached, the LED will start flashing again from the first feature or option.

















Once a feature is programmed

















- Other features can be programmed.
- The feature programming can be exited.

Exiting feature programming

- No activity for 30 seconds; after 30 seconds, the LED will turn ON orange for 2 seconds to confirm the end of the programming sequence.
OR
- Press and HOLD the programming button for 3 seconds. After 3 seconds, the LED will turn ON orange for 2 seconds to confirm the end of the programming sequence.

LED Diagnostics & Troubleshooting

LED	Description	Troubleshooting
Module Programming		
 Off	Module has no power.	Make sure the D2D harness is connected or that the 12 Volt is present between the red and black wires. If the 12 Volt is present, the module may be defective.
 Solid red	Waiting to begin the programming sequence.	Ensure the correct programming procedure is being followed.
 Flashes red & green	Initialization failed.	Reset the module and complete the programming again. If the issue persists, please contact Technical Support.
 Solid orange	Transponder functions were skipped.	(If compatible) when RXT mode is not desired or convenience features are needed, please reset and reprogram the module.
 Flashes green	All required CAN networks has been detected.	Normal operation.
 Flashes orange	1 of 2 CAN networks has been detected.	Normal operation
 Flashes orange slowly	Key2GO initiated.	Please follow the steps indicated in "Module programming" to complete the Key2GO programming.
 Solid green x 3 secs	Module was successfully programmed with all functions.	Normal operation
 Solid orange x 3 secs	Module was successfully programmed without transponder functions.	Normal operation.
Module Programming - Error Codes		
 Flashes red x 1	CAN2 not detected.	Check the CAN2 Orange/Green and Orange/Brown wire connections. Wake up the data bus by turning the ignition on and try again. If your installation does not require this connection, skip this step by pressing the programming button 5 times.
 Flashes red x 1	J1850 not detected.	Check the J1850 wire connection. Wake up the data bus by turning the ignition on and try again.
 Flashes red x 2	CAN1 not detected.	Check the CAN1 Tan and Tan/Black wire connections. Wake up the data bus by turning the ignition on and try again. If your installation does not require this connection, skip this step by pressing the programming button 5 times.
 Flashes red x 3	Bypass data not detected.	Check the bypass line connection. If more than one wire is used, make sure they are not inverted. Ensure the vehicle still operates correctly using the factory key.
 Flashes red x 4	Bypass processing error.	The bypass calculation failed. Reset the module and try again. If the condition persists, please contact Technical Support.
 Flashes red x 5	ISO 1 not detected.	The Yellow/Black wire did not detect the expected signal. Refer to "Installation (wiring diagrams & vehicle wiring reference charts)" to check the connections.
 Flashes red x 6	ISO 2 not detected.	The Orange/Black wire did not detect the expected signal. Refer to "Installation (wiring diagrams & vehicle wiring reference charts)" to check the connections.
 Flashes red x 7	MUX not detected.	The Violet/Green or Violet/Brown wire did not detect the expected voltage value. Refer to "Installation (wiring diagrams & vehicle wiring reference charts)" to check the connections.

LED	Description	Troubleshooting
External module synchronization		
	OBDII feature is not supported.	The diagnostic data bus was not detected, therefore the SmartStart features will be limited.
Activation Ground When Running (Status)		
	Ground When Running (Status) command received.	The module has initialized the remote start sequence.
	Ignition ON command received.	The module has received the Ignition ON command and is processing the remote start sequence.
	Start ON command received.	The module has received the Start ON command and is processing the remote start sequence.
	PTS shutdown error.	The PTS output from the module was not activated due to safety protection.
	CAN bus incorrectly detected.	Verify the CAN1 and CAN2 connections. Refer to "Installation (wiring diagrams & vehicle wiring reference charts)" to check the connections.
Commands		
	LOCK command received.	If the bypass module fails to flash, it did not receive the signal. Commands can come from RF or D2D.
	UNLOCK command received.	
	TRUNK command received.	
	AUX1 command received.	
	AUX2 command received.	
	AUX3 command received.	
Shutdown codes		
	Takeover successful.	Normal operation.
	Runsafe was not disabled.	No UNLOCK command was received prior to opening the door, or the 45 second timer expired in takeover mode.
	Brake was not detected.	The brakes were not detected, which prevents the system from shutting down the vehicle.
	Smart key was not detected.	The smart key was not detected, which prevents the system from shutting down the vehicle.
	Speed was detected.	The vehicle was detected as moving, which prevents the system from shutting it down.

Limited One Year Consumer Warranty

For a period of ONE YEAR from the date of purchase of a Directed Electronics remote start or security product, Directed Electronics. ("DIRECTED") promises to the original purchaser, to repair or replace with a comparable reconditioned piece, the security or remote start accessory piece (hereinafter the "Part"), which proves to be defective in workmanship or material under normal use, provided the following conditions are met: the Part was purchased from an authorized DIRECTED dealer; and the Part is returned to DIRECTED, postage prepaid, along with a clear, legible copy of the receipt or bill of sale bearing the following information: consumer's name, address, telephone number, the authorized licensed dealer's name and complete product and Part description.

This warranty is nontransferable and is automatically void if the Part has been modified or used in a manner contrary to its intended purpose or the Part has been damaged by accident, unreasonable use, neglect, improper service, installation or other causes not arising out of defect in materials or construction.

TO THE MAXIMUM EXTENT ALLOWED BY LAW, EXCEPT AS STATED ABOVE, ALL WARRANTIES, INCLUDING BUT NOT LIMITED TO EXPRESS WARRANTY, IMPLIED WARRANTY, WARRANTY OF MERCHANTABILITY, FITNESS FOR PARTICULAR PURPOSE AND WARRANTY OF NONINFRINGEMENT OF INTELLECTUAL PROPERTY, ARE EXPRESSLY EXCLUDED; AND DIRECTED NEITHER ASSUMES NOR AUTHORIZES ANY PERSON OR ENTITY TO ASSUME FOR IT ANY DUTY, OBLIGATION OR LIABILITY IN CONNECTION WITH ITS PRODUCTS. DIRECTED HEREBY DISCLAIMS AND HAS ABSOLUTELY NO LIABILITY FOR ANY AND ALL ACTS OF THIRD PARTIES INCLUDING DEALERS OR INSTALLERS. DIRECTED IS NOT OFFERING A GUARANTEE OR INSURANCE AGAINST VANDALISM, DAMAGE, OR THEFT OF THE AUTOMOBILE, ITS PARTS OR CONTENTS, AND DIRECTED HEREBY DISCLAIMS ANY LIABILITY WHATSOEVER, INCLUDING WITHOUT LIMITATION, LIABILITY FOR THEFT, DAMAGE, OR VANDALISM. IN THE EVENT OF A CLAIM OR A DISPUTE INVOLVING DIRECTED OR ITS SUBSIDIARY, THE PROPER VENUE SHALL BE SAN DIEGO COUNTY IN THE STATE OF CALIFORNIA. CALIFORNIA STATE LAWS AND APPLICABLE FEDERAL LAWS SHALL APPLY AND GOVERN THE DISPUTE. THE MAXIMUM RECOVERY UNDER ANY CLAIM AGAINST DIRECTED SHALL BE STRICTLY LIMITED TO THE AUTHORIZED DIRECTED DEALER'S PURCHASE PRICE OF THE PART. DIRECTED SHALL NOT BE RESPONSIBLE FOR ANY DAMAGES WHATSOEVER, INCLUDING BUT NOT LIMITED TO, ANY CONSEQUENTIAL DAMAGES, INCIDENTAL DAMAGES, DAMAGES FOR THE LOSS OF TIME, LOSS OF EARNINGS, COMMERCIAL LOSS, LOSS OF ECONOMIC OPPORTUNITY AND THE LIKE. NOTWITHSTANDING THE ABOVE, THE MANUFACTURER DOES OFFER A LIMITED WARRANTY TO REPLACE OR REPAIR AT DIRECTED'S OPTION THE PART AS DESCRIBED ABOVE.

This warranty only covers Parts sold within the United States of America and Canada. Parts sold outside of the United States of America or Canada are sold "AS-IS" and shall have NO WARRANTY, express or implied. Some states do not allow limitations on how long an implied warranty will last or the exclusion or limitation of incidental or consequential damages. This warranty gives you specific legal rights and you may also have other rights that vary from State to State. DIRECTED does not and has not authorized any person or entity to create for it any other obligation, promise, duty or obligation in connection with this Part. For further details relating to warranty information of Directed products, please visit the support section of DIRECTED's website at: www.directed.com

920-10012-01 2013-07

This Interface kit / Data Bus Interface part has been tested on the listed vehicles. Other vehicles will be added to the select vehicle list upon completion of compatibility testing. Visit website for latest vehicle application guide. DISCLAIMER: Under no circumstances shall the manufacturer or the distributors of the bypass kit / data bus interface part(s) be held liable for any consequential damages sustained in connection with the part(s) installation. The manufacturer and its distributors will not, nor will they authorize any representative or any other individual to assume obligation or liability in relation to the interface kit / data bus interface part(s) other than its replacement. N.B.: Under no circumstances shall the manufacturer and distributors of this product be liable for consequential damages sustained in connection with this product and neither assumes nor authorizes any representative or other person to assume for it any obligation or liability other than the replacement of this product only.

Protected by U.S. Patents: 5,719,551; 6,011,460 B1 *; 6,243,004 B1; 6,249,216 B1; 6,275,147 B1; 6,297,731 B1; 6,346,876 B1; 6,392,534 B1; 6,529,124 B2; 6,696,927 B2; 6,756,885 B1; 6,756,886 B2; 6,771,167 B1; 6,812,829 B1; 6,924,750 B1; 7,010,402 B1; 7,015,830 B1; 7,031,826 B1; 7,046,126 B1; 7,061,137 B1; 7,068,153 B1; 7,205,679 B1; Cdn. Patent: 2,320,248; 2,414,991; 2,415,011; 2,415,023; 2,415,027; 2,415,038; 2,415,041; 2,420,947; 2,426,670; 2,454,089; European Patent: 1,053,128; Pat. Pending: 2,291,306. Made in Canada.

Vehicle Takeover

- 1** Press the remote start button on the transmitter to start the vehicle.*



- 2** Press the Unlock button on the factory or aftermarket remote.*



- 3** Enter the vehicle

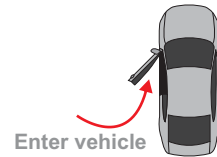

- 4** Insert the key into the ignition barrel and turn it to the ON position.

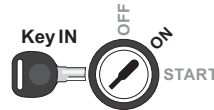

- 5** Press the brake pedal, put the car in gear and drive off.



* Your aftermarket remote may differ from the model shown in the illustrations.

Pit Stop Mode

The Pit Stop Mode feature is practical when you need to stop and run an errand, but wish to keep the engine running.

- 1** Stop the vehicle in a safe parking spot and put the gear in Park (P).



- 2** Press the button to remote start the vehicle.* The parking lights will flash once to indicate the vehicle is now in Pit Stop Mode.



- 3** Remove the key from ignition. It is now safe to leave the engine running and exit the vehicle with the Smart Key in hand.

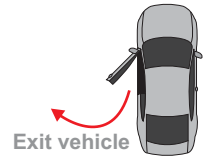











Note: We recommend that you always lock the doors of your vehicle when leaving it unattended.

* Your aftermarket remote may differ from the model shown in the illustrations.

List of Available Commands

Note that the information below is for Viper, Clifford and Python models. Icons and commands may differ depending on the remote brand and model purchased. Refer to your authorized installation center for more information.

Button(s)	Actions
	Press & hold for 1 second to lock.
	Press & hold for 1 second to unlock.
	Press & hold for 1 second to remote start.
	Press & hold for 5 seconds to activate the trunk release (optional).
<i>f</i> x1 + 	Press <i>f</i> once, then  to activate the rear hatch/tail glass release (optional).*
<i>f</i> x3 + 	Press <i>f</i> 3 times, then  to activate the panic mode.
<i>f</i> x1 + 	Press <i>f</i> once, then  to reset the remote starter runtime.

* This output is configurable. see your authorized installation center for more information.

Notes
